

BORE GAUGE

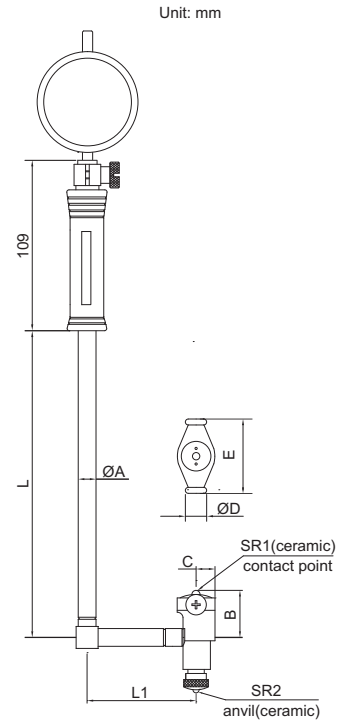

2827-160A

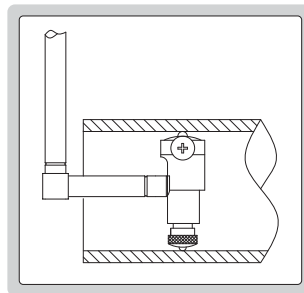

■ Optional accessory: setting ring (code 6312)

(mm)

Code	Range	Indicator	Accuracy	Repeatability	ØA	B	C	ØD	E	L	L1
2827-160A	50-160mm	dial indicator code 2308-10FA range 10mm, graduation 0.01mm	±0.018mm	0.003mm	12.8	28.5	9.2	13	35	141	76.2
2827-250A	160-250mm		±0.018mm	0.003mm	14.5	62.0	12.7	13	74.5	391	100
2827-450A	250-450mm		±0.018mm	0.003mm	14.5	91.5	15.0	15	101.5	391	100

(mm)

Code	Range	Indicator	Accuracy	Repeatability	ØA	B	C	ØD	E	L	L1
2127-160	50-160mm	digital indicator code 2108-10F range 12.7mm/0.5", resolution 0.002mm/0.0001"	±0.018mm	0.003mm	12.8	28.5	9.2	13	35	141	76.2
2127-250	160-250mm		±0.018mm	0.003mm	14.5	62.0	12.7	13	74.5	391	100
2127-450	250-450mm		±0.018mm	0.003mm	14.5	91.5	15.0	15	101.5	391	100